

**DESCRIPTION**

The Altec Lansing 938 multi-purpose loudspeaker systems are both compact and versatile. They were designed to be used as high level stage monitors in portable sound reinforcement and can also be used as a small, full range system in churches or night clubs or for reinforcement installation in any small to medium room.

The 938 may be placed at 90°, 50° or 30° angles (referenced to floor-plane mounting surface). The reversible grille permits a right-side-up orientation regardless of the speaker's position. The 938 uses an upgraded version of the Altec Lansing 604, long recognized for uniform frequency response and high efficiency, with low and high frequency elements mounted coaxially to produce a single point source of sound. New materials have been used in the low and high frequency voice coils

which allow the 938 to handle large power amplifier outputs. The dividing network is designed with 12 dB per octave slopes for a smooth and gradual transition at crossover and has adjustable attenuation at high frequencies.

The enclosure is constructed of ¾" birch plywood and is finished in a black texture surface polyurethane paint with a black grille. The 938 also features recessed carrying handles and durable metal corner guards to protect the cabinet during handling and set-up. In addition, convenient tee nut mounting points are provided to aid in hanging the system in a permanent installation.

When used as a monitor or a small main system, the 938 will supply the high level quality sound that is required for churches, hotels and other installations.

SPECIFICATIONS

System Type:	Two way, vented, full range loudspeaker system
Pressure Sensitivity:	100 dB SPL (1W, 1M, 80 Hz-15 kHz, re: 20 μ Pa, see Note 2)
Frequency Response:	80 Hz-15 kHz (see Figure 1, Note 3)
Power Handling:	150 watts, 80 Hz-15 kHz, AES method (see Note 4) 300 watts, 80 Hz - 15 kHz continuous program material (see Note 12) 600 watts peak power, 80 Hz-15 kHz (see Note 13)
Maximum Long Term Output:	122 dB SPL (1M, re: 20 μ Pa, see Note 5) 128 dB SPL peak
Impedance:	7.2 Ω minimum, maximum inductive phase angle = 68 $^\circ$ at 8 Hz, maximum capacitive phase angle = 59 $^\circ$ at 20 Hz (see Figures 3 and 4, Note 11)
Distribution Pattern:	60 $^\circ$ horizontally by 40 $^\circ$ vertically (see Figure 8)
Components:	16" coaxial loudspeaker, part number 50-03-026768
Crossover Network:	938-8AD part number 56-06-027683, 938-8AE part number 56-06-027506 Crossover frequency 2 kHz with choice of

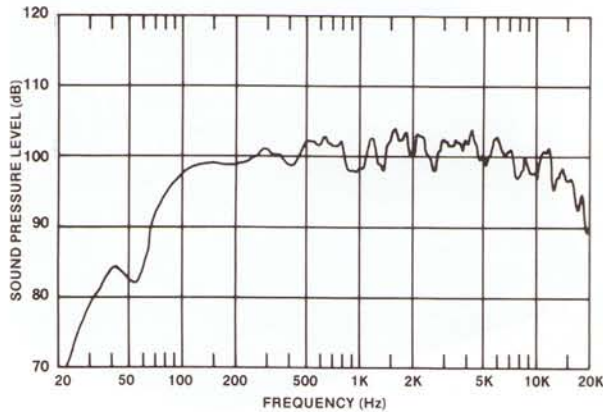

Figure 1. Frequency Response (See Notes 1 and 3)

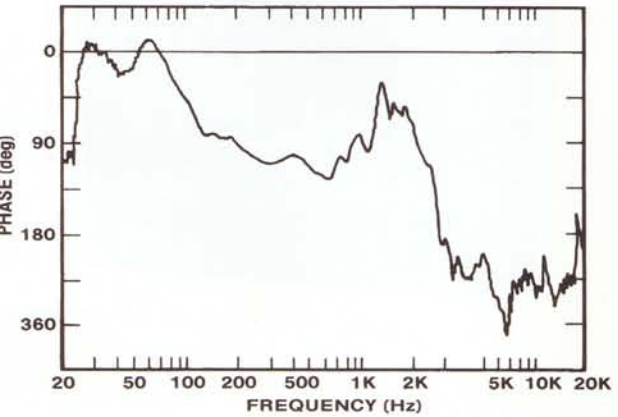

Figure 2. Phase Response (See Note 6)

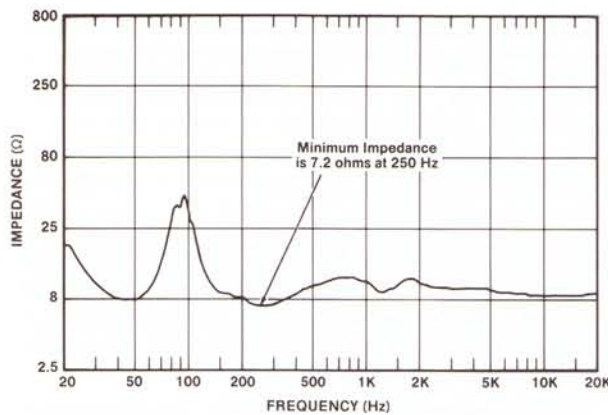

Figure 3. Magnitude of Impedance

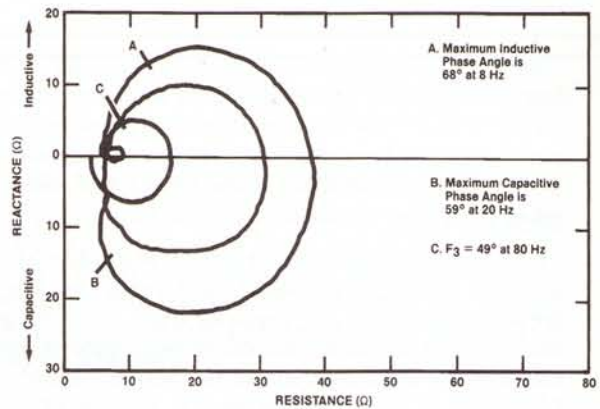

Figure 4. Complex Impedance

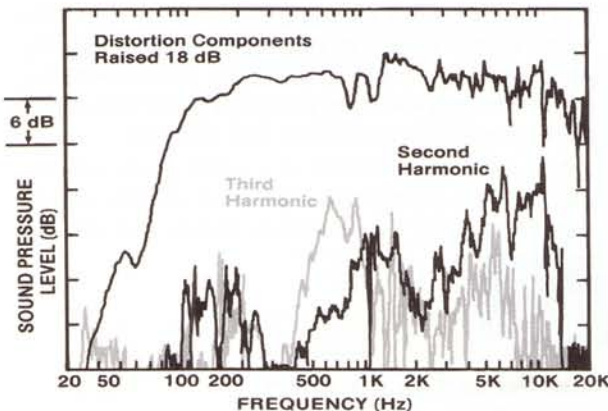

Figure 5. Harmonic Distortion at .01 Rated Power (1.5 watts, See Note 7)

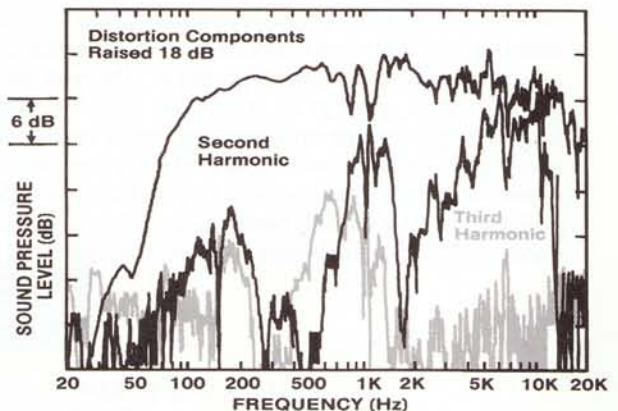

Figure 6. Harmonic Distortion at 0.1 Rated Power (15 watts, See Note 7)

Enclosure:	Vented type for optimum response, built of 3/4 inch (1.9 cm) birch plywood lined with glass wool, includes tee nut mounting points on each side and a removable grille.
Input Connector:	938-8AD; red and black five way binding posts and two 1/4" phone jacks wired in parallel. 938-8AE; red and black five way binding posts and XLR connectors wired in parallel (Pin 2 is positive and Pin 3 is negative). Model 26420
Replacement H.F. Diaphragm:	R604-8L
L.F. Recone Kit:	Model RG 938
Replacement Grille:	20.5" (52.1 cm) high 22" (55.8 cm) wide 21.5" (54.6 cm) deep
Dimensions:	
Net Weight:	58 lbs. (26.4 kg)
Shipping Weight:	60 lbs. (27.3 kg)
Finish:	Black, texture finish, polyurethane paint, black grille cloth

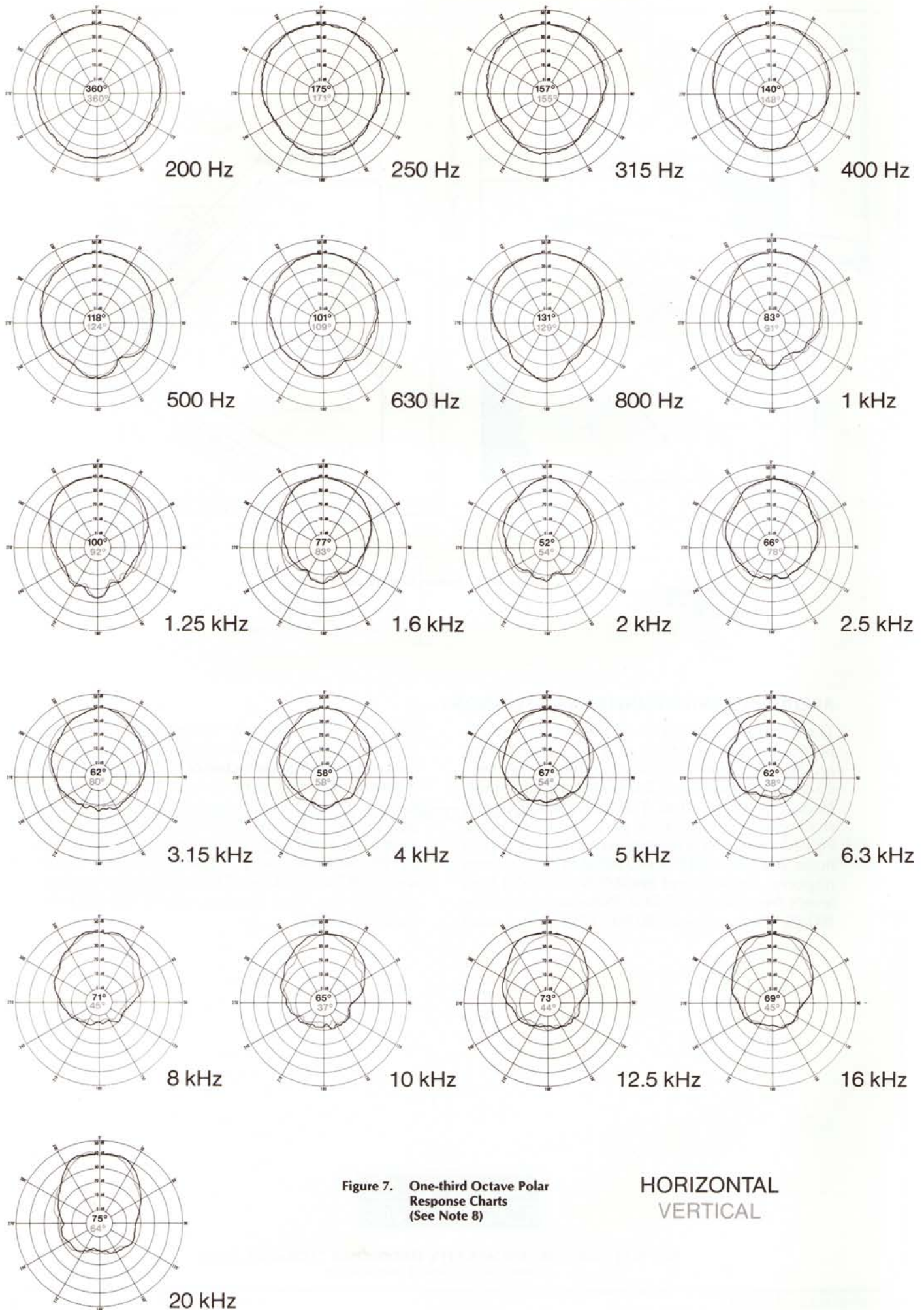

Figure 7. One-third Octave Polar Response Charts (See Note 8)

HORIZONTAL
VERTICAL

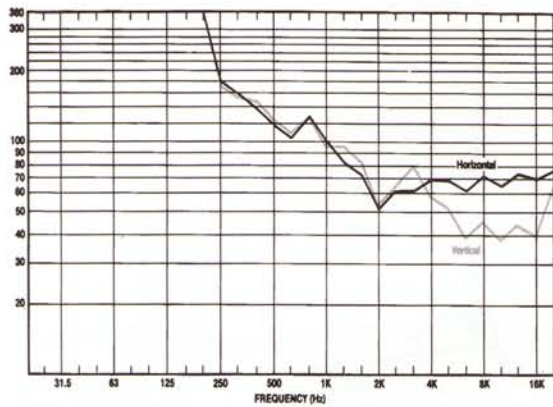

Figure 8. Coverage Angle

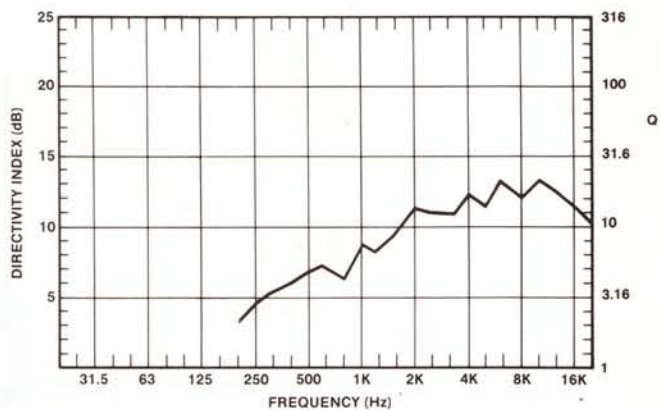

Figure 9. Q and DI

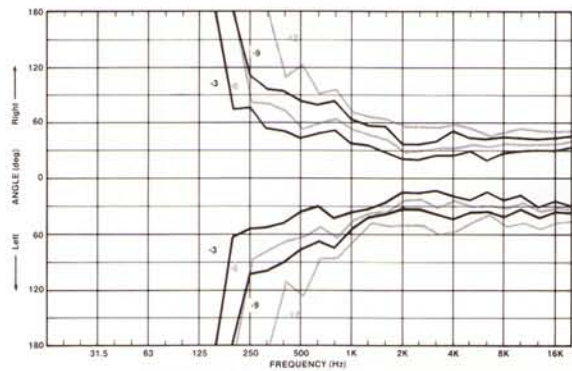

Figure 10. Horizontal Off-Axis Response Contours

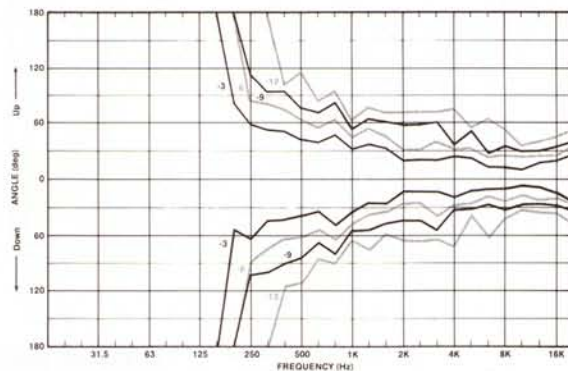

Figure 11. Vertical Off-Axis Response Contours

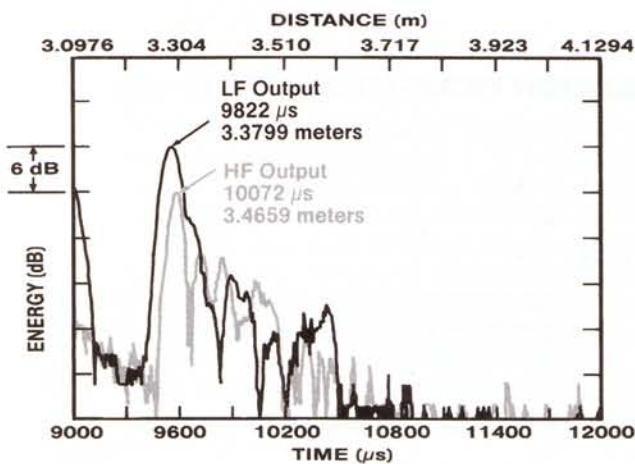

Figure 12. Energy Time Curve (See Note 9)

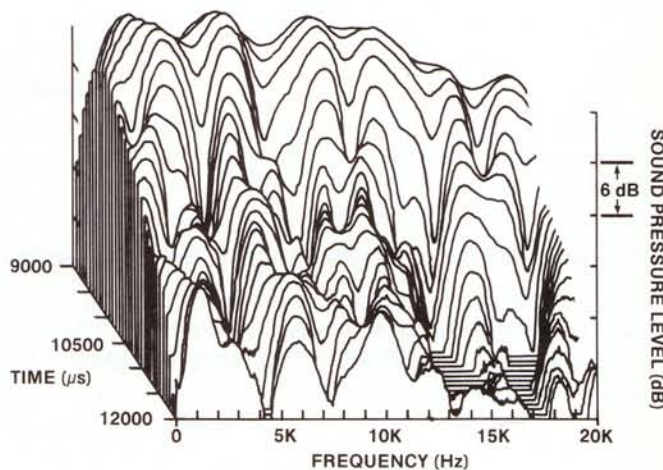

Figure 13. Time Energy Frequency Curve (See Note 10)

NOTES ON MEASUREMENT CONDITIONS

- Figure 1 measurement was taken with network attenuation set in the "Flat" position.
- Pink noise signal, one watt calculated using E^2/Z_{min} , 3.16 meter measurement distance referred to one meter.
- On-axis, one watt calculated using E^2/Z_{min} , 3.16 meter. Measurement distance referred to one meter, low frequencies corrected for anechoic chamber error.
- This system rating patterned after the AES method for individual drivers, where the test signal is pink noise with 6 dB crest factor over the bandwidth of the system, with power calculated using E^2/Z_{min} , for two hours.
- This measurement made under the same conditions as Pressure Sensitivity, but at rated power, and takes into account any power compression effects due to non-linearities in the system.
- Phase response of the system measured at a time corresponding to the energy arrival of the high frequency component, as noted on Figure 12.
- Distortion components invalid above 10 kHz. The percentage distortion at any given frequency may be found by graphically

taking the difference between the fundamental and harmonic, adding 18 dB, and applying the formula: percentage distortion = $100 \times 10^{-\text{dB change}/20}$

- The axis of rotation for all polar plots is the apparent apex of the high frequency horn. Plots below 200 Hz have not been shown because of their lack of pertinent information.
- The time window has been chosen to resolve the arrival times of low and high frequency components. Frequency bandwidth of measurement, 800 Hz-2.8 kHz
- Response decay of the system. Time window is the same as used in Figure 12, Energy Time Curve.
- The loudspeaker system should be connected to the eight ohm tap of amplifiers using transformer coupled output sections.
- Continuous program is defined as 3 dB greater than the AES rating using a pink noise signal with 6 dB crest factor.
- Peak power is defined as 6 dB greater than the AES rating using a pink noise signal with 6 dB crest factor.

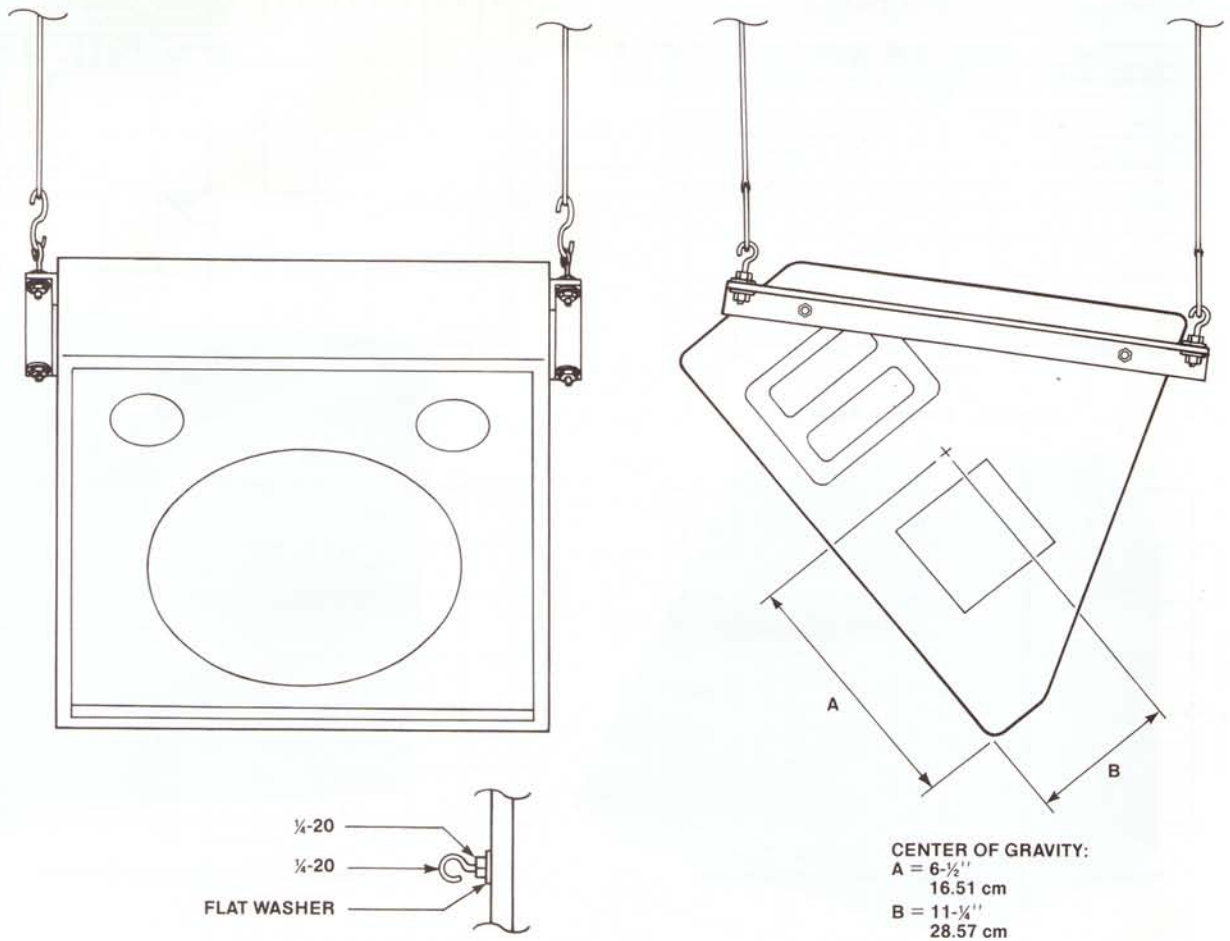

Figure 14. Mounting Data

MOUNTING INFORMATION FOR FIXED INSTALLATION

The loudspeaker system is supplied with $\frac{1}{4}$ -20 threaded inserts which allow suspension mounting in either 50° or 30° angles (referenced to

a ceiling-plane mounting surface). The user must supply eyebolts, hexnuts, washers, "S" hooks, and cables or chains.

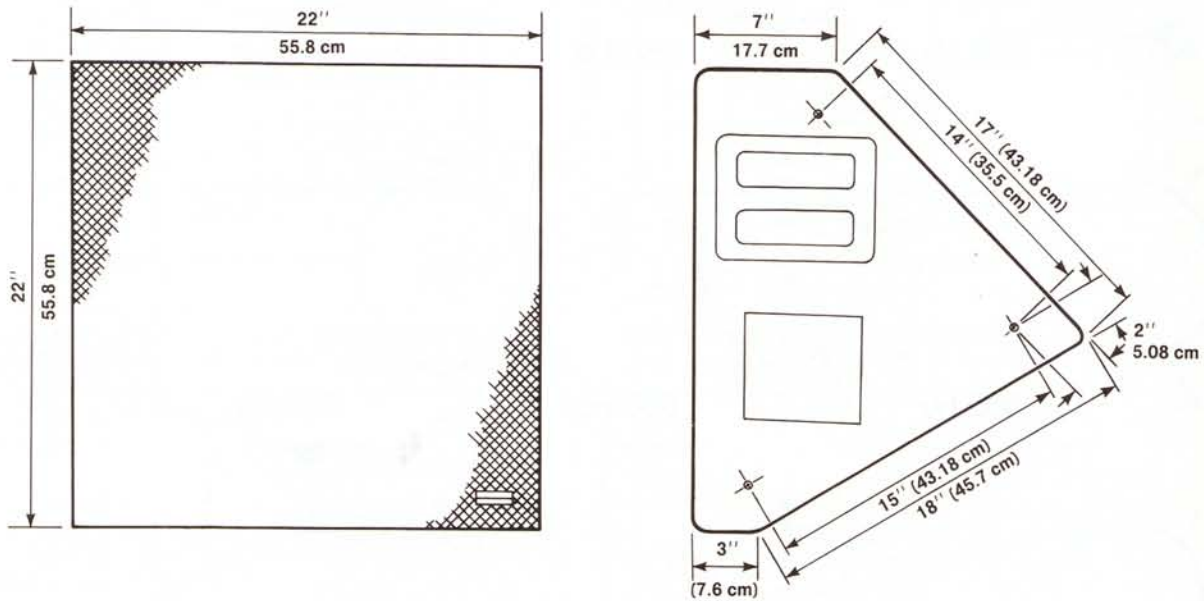

Figure 15. System Dimensions

ARCHITECT'S AND ENGINEER'S SPECIFICATIONS

The loudspeaker shall be of the two-way multi-purpose type, consisting of a 16" coaxial type loudspeaker and a dividing network having a crossover frequency of 2 kHz with variable high-frequency attenuation. The loudspeaker system shall meet the following performance criteria. Power rating, 150 w (average) of continuous pink noise, band-limited from 80 Hz-15 kHz. Frequency response, smooth and uniformly usable at high levels from 80 Hz-15 kHz. Pressure sensitivity, 100 dB SPL at one watt, 80 Hz - 15 kHz, measured

from one meter on axis. Impedance, 7.2 ohms, minimum. The enclosure shall be of the ported bass reflex type constructed of $\frac{3}{4}$ " (1.9 cm) birch plywood damped with sound absorbent glass wool. The finish shall be black spatter-finish polyurethane paint. The dimensions shall be 20 $\frac{1}{2}$ " (52.1 cm) high by 22" (55.8 cm) wide by 21 $\frac{1}{2}$ " (54.6 cm) deep. The loudspeaker shall weigh 58 lbs. (26.4 kg). The loudspeaker system shall be the Altec Lansing Model **938-8AD** or Model **938-8AE**.



P.O. BOX 26105, OKLAHOMA CITY, OKLAHOMA 73126-0105, U.S.A.
©1989 ALTEC LANSING CORPORATION